



Filters . Accumulators

# Low / Medium Pressure Filter

Inline mounting

## Type : 40/160-LE/LEN



### Hydraulic Symbol

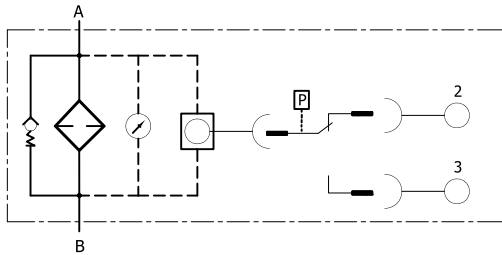

### Technical Data

#### Material of Construction

- Head : Aluminium Alloy.
- Bowl : Carbon Steel.
- Seals : Nitrile / Viton / EPDM.
- Paint : Bowl Externally painted in RAL-5010.  
Others on request.

- Design : Simplex Inline
- Max. Pressure (PS) : 40 / 160 Bar.
- Test Pressure (PT) : 1.43 x PS
- Temperature range : -20°C to +100°C (Standard)
- Connection : Upto 1-1/2" BSP(F)
- Element design : LE Series - EPE standard  
LEN Series - As per DIN-24550

### Description

The 40/160-LE/LEN series Filters are used for direct installation in the pipeline and provide wear protection of downstream components & systems. Simplex in design for inline mounting the filter inlet & outlet are located the opposite sides. The flow path arrow (inlet to outlet) is marked on filter head.

The Filter head is provided with an element locating spigot. The Filter bowl is mounted below the filter head and is unscrewed for maintenance.

### Accessories

Maintenance indicator - for monitoring the filter element contamination status. Available in various designs including

- Optical (pop-up version) with Electrical option.
- Optical (dual dial version) with Electrical option.
- Optical-Electrical with 2 switching points.

Magnet - to protect the filter from ferrous contamination.

Bypass valve - to protect the filter element during start-up and over pressurisation due to clogging.

Vent valve - for removing the air from the filter during starting and for safe depressurisation.

Drain valve - for draining the filter during servicing.

### Filter Element

The Filter Element is of star-pleated design with optimised pleat density for providing prolonged life.

The filter element is of Out-to-In design and the contaminant is retained outside the filter element and collected in the filter bowl.

The elements are available in various media options and selected based on the required oil cleanliness, initial pressure drop and dirt holding capabilities.

Media options for the filter element include

SS Wire Mesh - Cleanable, Nominal filtration.

Paper - Non-cleanable, Nominal filtration.

Non-woven - Non-cleanable, Nominal filtration.

Inorganic glass fibre - Non-cleanable, Absolute filtration acc. to ISO-16889.

Aquasorb - Water absorbing media, Non-cleanable.

For special applications / fluids the filter elements are supplied with SS hardware (end caps & inner tube) and / or different adhesives.

Technical specifications subject to change.

# Ordering Code - Filter

1    2    3            4    5    6ab    7    8    9ab    10    11    12    13  
**160** - **LE** - **0013** - **H10XL** - **A** - **00** - **0** - **9** - **A5.0** - **RO** - **P** - **0** - **0** /

1	<b>Max. working pressure</b>	40 Bar 160 Bar	= <b>40</b> = <b>160</b>
2	<b>Filter type</b>	Inline - EPE Standard Element Inline - Element acc. to DIN 24550	= <b>LE</b> = <b>LEN</b>
3	<b>Nominal Size</b>	Filter type LE  Filter type LEN	= <b>0005 0008 0013</b> <b>0015 0018</b> <b>0020 0030 0045</b> = <b>0040 0063 0100</b> <b>0160 0250 0400</b>
4	<b>Filtering Media &amp; Filtration Grade</b>	<u>Nominal Filtration Grade in µm</u> SS Wire Mesh   Cleanable  Paper   Non-cleanable  Non-Woven   Non-cleanable  <u>Absolute Filtration Grade (ISO16889) in µm</u> Glass Fibre with epoxy wire mesh support   Non-cleanable  Glass Fibre with plastic mesh support   Non-cleanable  Water Absorbing Glass Fibre   Non-cleanable	= <b>G10 G25 G40</b> <b>G60 G80 G100</b> Others on request  = <b>P5 P10 P25</b>  = <b>VS10 VS25 VS40</b> <b>VS60</b>  = <b>H1XL H3XL H5XL</b> <b>H6XL H10XL H16XL</b> <b>H20XL</b>  = <b>H1XP H3XP H5XP</b> <b>H6XP H10XP H16XP</b> <b>H20XP</b>  = <b>AS1 AS3 AS6</b> <b>AS10 AS20</b>
5	<b>Differential Pressure of Element</b>	<u>Maximum allowed differential pressure</u> 30 Bar 60 Bar 160 Bar	= <b>A</b> (standard) = <b>D</b> = <b>C</b>
6a	<b>Element Adhesive</b>	Standard Adhesive T=100°C Epoxy Adhesive (for fuels) High Temp. Adhesive T=160°C	= <b>0</b> (standard) = <b>1</b> = <b>E</b>
6b	<b>Element Hardware</b>	Standard (Carbon Steel / Polyamide) All Stainless Steel (30 Bar DP)	= <b>0</b> (standard) = <b>V</b>
7	<b>Magnet</b>	Without With ring magnet <sup>(a)</sup>	= <b>0</b> (standard) = <b>X</b>
8	<b>Bypass Valve</b>	Without With Bypass Valve - 0.3 Bar With Bypass Valve - 0.8 Bar With Bypass Valve - 1.5 Bar With Bypass Valve - 2.0 Bar With Bypass Valve - 2.5 Bar With Bypass Valve - 3.0 Bar With Bypass Valve - 3.5 Bar With Bypass Valve - 5.0 Bar With Bypass Valve - 7.0 Bar With special setting Bypass valve	= <b>0</b> = <b>1</b> = <b>2</b> = <b>3</b> = <b>4</b> = <b>5</b> = <b>6</b> = <b>7</b> (std for 40-LE/LEN) = <b>8</b> = <b>9</b> (std for 160-LE/LEN) = <b>Bx</b> (x = pressure)

\* Before ordering, check for availability.

<sup>(a)</sup> Magnets kept loose under the elements.

## Ordering Code - Filter

1 2 3 4 5 6ab 7 8 9ab 10 11 12 13  
**160** - **LE** - **0013** - **H10XL** - **A** - **00** - **0** - **9** - **A5.0** - **R0** - **P** - **0** - **0** /

9a	<b>Maintenance Indicator - type</b>	Without Optical (Pop-up) Optical(Pop-up) + Electrical with DIN Plug Optical(Pop-up) + Electrical with Lamp Optical + Electrical with 2 Switching points - set to operate at 75% and 100% Optical (Dual dial) Optical(dial) + Electrical with DIN Plug Optical(dial) + Electrical with Lamp Special	= <b>0</b> (standard) = <b>A..</b> = <b>B..</b> = <b>D..</b> = <b>T..</b>  = <b>AD..</b> = <b>BD..</b> = <b>DD..</b> = <b>SP</b>
9b	<b>Maintenance Indicator - cracking pressure</b>	Without 0.8 Bar 1.5 Bar 2.5 Bar 4.2 Bar 5.0 Bar 6.0 Bar 7.0 Bar Other pressure (in Bar)	= - (standard) = <b>..0.8</b> = <b>..1.5</b> = <b>..2.5</b> (std- 40-LE/LEN) = <b>..4.2</b> = <b>..5.0</b> (std- 160-LE/LEN) = <b>..6.0</b> = <b>..7.0</b> = ..... as applicable
10	<b>Inlet / Outlet - connections</b> (Refer C1 on pg.5)	Catalogue Standard Connections  Special connection With adaptor	= <b>R0</b> (G1   G1-1/4   G 1-1/2) = <b>X0</b> (to be specified) = <b>RA0</b> (to be specified)
11	<b>Seal Material</b>	Nitrile Viton	= <b>P</b> = <b>V</b>
12	<b>Housing Material</b>	Standard - as per catalogue Special	= <b>0</b> = <b>SP</b>
13	<b>Other Options</b> (multiple options possible)	Without With 1/4" air vent port - duly plugged With 1/4" BSP Air Vent Valve With 1/4" drain port - duly plugged With 1/4" CS drain valve in bowl With 1/4" SS drain valve in bowl Design with 3 mounting inserts Filter Element with Outer Sleeve	= <b>0</b> = <b>EP</b> = <b>E</b> = <b>4</b> = <b>DV</b> = <b>DVX</b> = <b>3I</b> = <b>X</b>

\* Before ordering, check for availability

## Ordering Code - Filter Element

3 4 5 6ab 8 11  
**2.** **0013** - **H10XL** - **A** - **00** - **0** - **P**

## Ordering Code - Filter Seal Kit

1 2 3 9a 10 11 12  
**D** - **160** - **LE** - **0013** - **A** - **R0** - **P** - **0**

# Maintenance Indicators

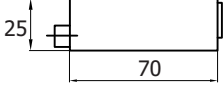
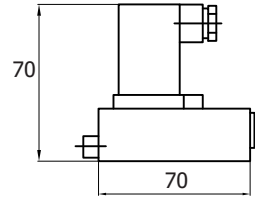
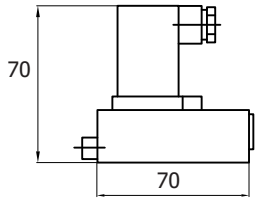
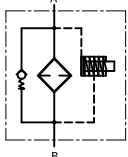
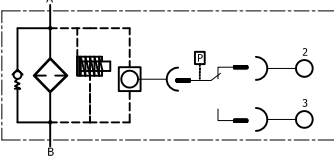
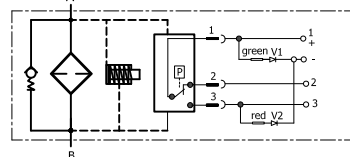
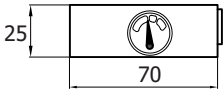
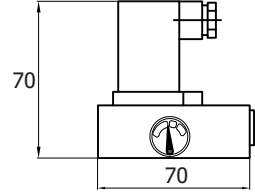
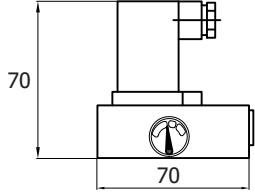
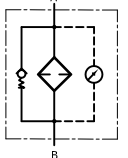
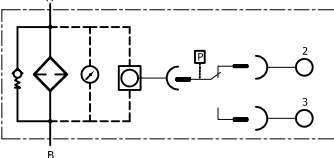
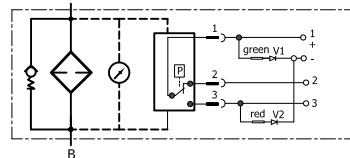
		
A = Optical (Pop-up)	B = Optical (Pop-up) + Electrical	D = Optical (Pop-up) + Electrical with 2 LEDs
Ordering Code <b>F-xx-A0-00-00-P</b>	Ordering Code <b>F-xx-GW-02-00-P</b>	Ordering Code <b>F-xx-GW-26-00-P</b>
		
		
AD = Optical (Dual Dial)	BD = Optical (Dual Dial) + Electrical	DD = Optical (Dual Dial) + Electrical with 2 LEDs
Ordering Code <b>FD-xx-A0-00-00-P</b>	Ordering Code <b>FD-xx-GW-02-00-P</b>	Ordering Code <b>FD-xx-GW-26-00-P</b>
		

## Maintenance Indicator functioning

These indicators work on the differential pressure and operate when a preset pressure differential is reached between the inlet & outlet ports.

In the pop-up version a red indicator pin pops out in the housing chamber thereby indicating the state whereas in the dual dial version two dial gauges - with green, yellow & red bands - placed on opposite side indicate the condition. If available, the electronic switching element is also triggered.

In the 2-switching points version (type T) the green LED glows in operating condition, yellow LED glows when 75% of the preset pressure differential is reached and red LED at 100%.

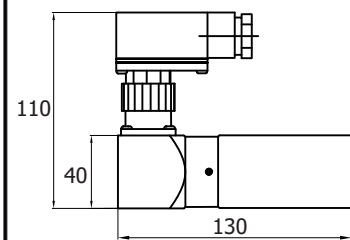

T = Optical/Electrical with 3 LEDs & 2 Switching points

Ordering Code  
**R-xx-GW-09-Z0-P**

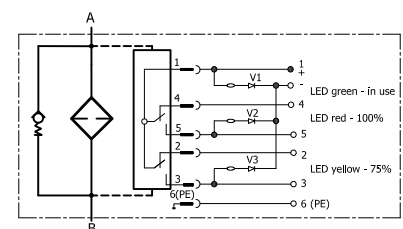

## Tightening Torque Values (Nm ±10%)

Type	Inlet/Outlet Ports		Bowl to head Torque	Mounting Holes	
	Size	Torque		Size	Torque
40/160 LE 0005-0013	G 1"	150	40	M8	12
40/160 LE 0015-0018	G 1-1/4"	160	50	M8	12
40/160 LE 0020-0045	G 1-1/2"	175	60	M12	15
40/160 LEN 0040-0100	G 1"	150	40	M8	12
40/160 LEN 0160-0400	G 1-1/2"	175	60	M12	15

xx - preset differential pressure (bar)

# Dimensions

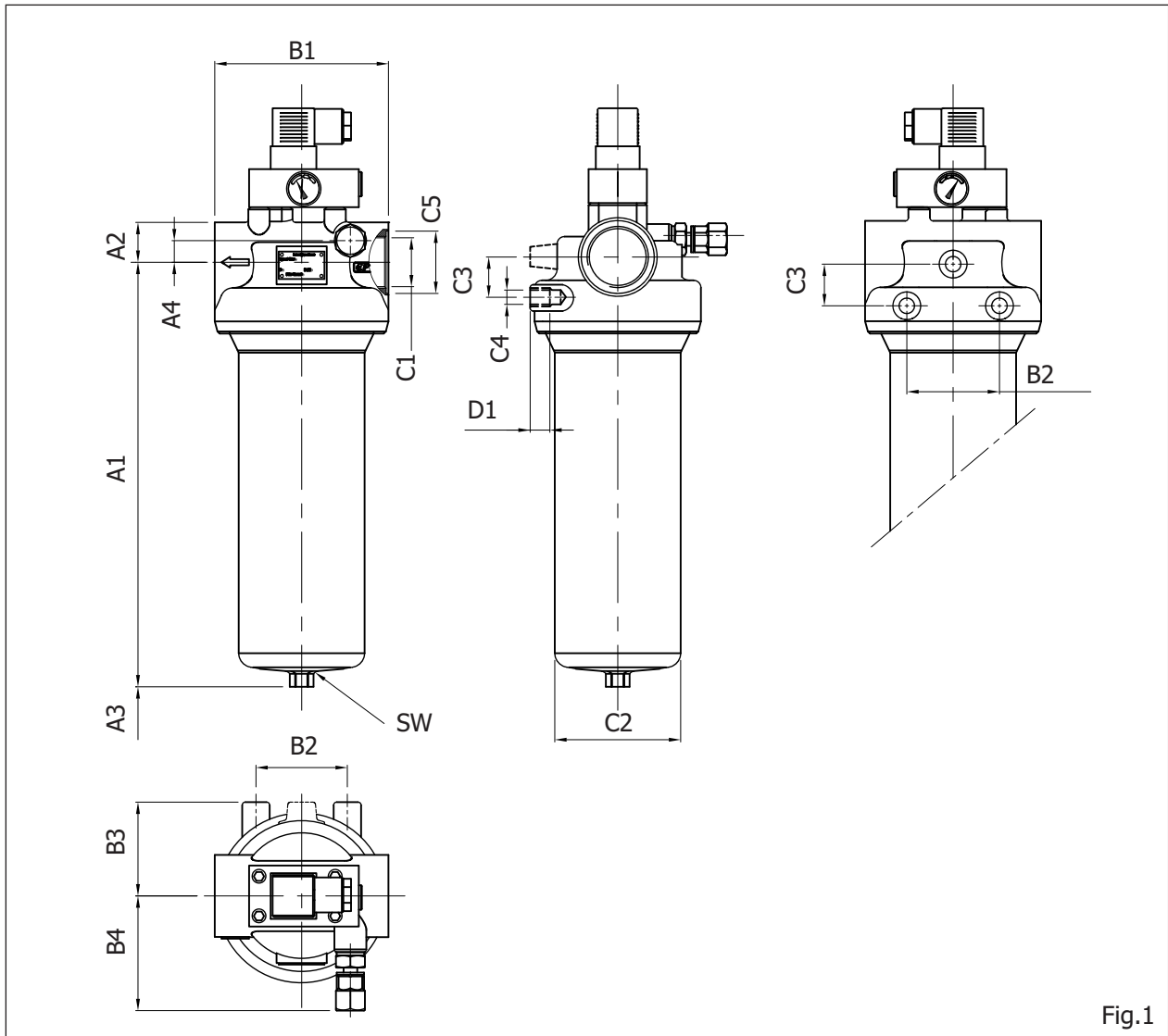

Fig.1

## Filter housing for Filter Elements in accordance with EPE standard

Type	Capacity in ltr	Weight in kg <sup>1)</sup>	A1	A2	A3 <sup>2)</sup>	A4	B1	B2	B3	B4	C1 Connection	C2	C3	C4	C5	D1	SW
40/160 LE 0005	0.21	1.47	155		100												
40/160 LE 0008	0.35	1.69	216	32		14	83	45	45	62	G 1" 20 dp	Ø57	21		Ø40	19	
40/160 LE 0013	0.53	2.03	308														
40/160 LE 0015	0.76	3.87	260	38	120	15	113	60	60	72	G 1¼" 20 dp	Ø77	28	M8	Ø50	10	24
40/160 LE 0018	0.96	4.20	313														
40/160 LE 0020	1.13	4.86	237														
40/160 LE 0030	1.60	6.25	330	38		19	138	80	70	76	G 1½" 20 dp	Ø98	42	M12	Ø56	14	27
40/160 LE 0045	2.40	8.16	478														

## Filter housing for Filter Elements in accordance with DIN 24550

Type	Capacity in ltr	Weight in kg <sup>1)</sup>	A1	A2	A3 <sup>2)</sup>	A4	B1	B2	B3	B4	C1 Connection	C2	C3	C4	C5	D1	SW
40/160 LEN 0040	0.21	1.47	155		100												
40/160 LEN 0063	0.35	1.69	216	32		14	83	45	45	62	G 1" 20 dp	Ø57	21	M8	Ø40	10	19
40/160 LEN 0100	0.53	2.03	308														
40/160 LEN 0160	1.13	4.86	237														
40/160 LEN 0250	1.60	6.25	330	38	120	19	138	80	70	76	G 1½" 20 dp	Ø98	42	M12	Ø56	14	27
40/160 LEN 0400	2.40	8.16	478														

<sup>1)</sup> = Weight including standard filter element and maintenance indicator

<sup>2)</sup> = Servicing height for filter element replacement

All dimensions in mm

# Spare parts list

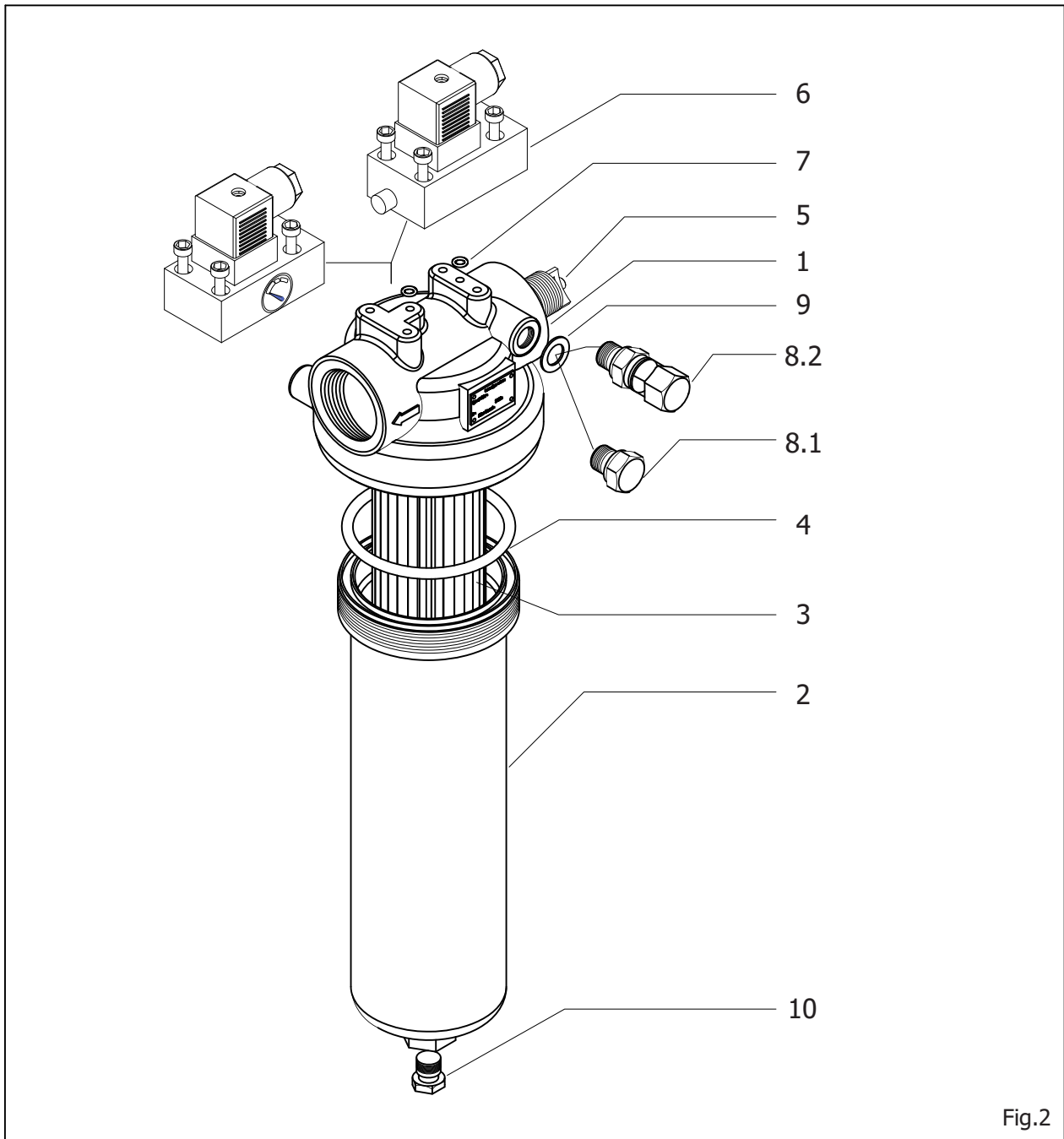

## Spare Parts List

		Size LE Size LEN		0005 0040	0008 0063	0013 0100	0015	0018	0020 0160	0030 0250	0045 0400
Item #	Qty.	Description	Material								
1	1	Filter Head	Aluminium	-							
2	1	Filter Bowl	Carbon steel	-							
3	1	Filter Element	Various	As per "Ordering Code - Filter Element"							
4	1	Housing O-Ring	Buna N/Viton	Sold as kit - "Ordering Code - Filter Seal Kit"							
5	1	Bypass Valve	Al / synthetic	Part No.BYP01/xx	Part No.BYP02/xx	Part No.BYP03/xx					
6	1	Indicator	Aluminium	As per Section "Maintenance Indicator"							
7	2	Indicator O-Rings	Buna N/Viton	Sold as kit - "Ordering Code - Filter Seal Kit"							
8.1	1	Air Vent plug	Carbon Steel	Part No.AVP01							
8.2	1	Air Vent Valve	Bronze	Part No.AOO001							
9	1	Seal Ring for air vent	Copper	Sold as kit - "Ordering Code - Filter Seal Kit"							
10	1	Drain plug	Steel	Part No.DBP01							

xx - Cracking pressure (bar)

## Installation

Before installation, conduct a visual check to ensure that the filter has not suffered any damage during shipping / handling. Verify that the requested type matches with what stamped on the nameplate.

Verify operating pressure with name plate information.

During assembly of the filter the tightening torques (refer page 4), the flow direction (direction arrows on the filter head) and the required service height (A3 in fig.1) of the filter element are to be taken into consideration.

Mount the filter assembly using the mounting holes on the filter head (C4) considering the flow direction. Failure to observe flow direction during assembly with cause damage to the filter element and components downstream.

Tighten the mounting bolts to specified torques (page 4).

We recommend using a suitable safety relief valve in the system to ensure the user and equipment are protected against possible damage caused by pressure surges.

Provide for the required servicing clearance below the filter for cleaning / replacing the filter element.

These filters must preferably be installed in vertical position with the filter bowl at the bottom to ensure proper venting and draining.

Proceed to the assembly ensuring the filter is not subjected to any abnormal forces and also fastened to avoid the transmission of vibrations. Tighten the inlet and outlet connections to the specified torques.

Make sure the optical part of the indicator is visible and the electricals connected appropriately.

If the maintenance indicator is ignored the bypass valve, if available, will open when the pressure differential increases thereby bypassing the filter element and contaminated fluid will pass to the clean side of the filter outlet thereby compromising the filtration effectiveness and risking the downstream components.

## Connecting electrical indicator

Connect indicator using the three wired cable.

Verify electrical ratings on the indicator (6) name plate.

Connection settings:

- |            |                                  |
|------------|----------------------------------|
| 1. Closer  | 1 (black) + 3 (blue)             |
| 2. Opener  | 1 (black) + 2 (brown)            |
| 3. Changer | 1 (black) + 2 (brown) + 3 (blue) |

## Special Instructions

It is strictly forbidden to:

- weld or solder or carry out any mechanical operations on the filter.
- engrave or permanently stamp the surfaces of the filter and / or carry out other operations that could affect or change the mechanical properties of the filter.
- use the filter as a structural element: it should not be subjected to stresses or loads.
- change the data of the nameplate and / or filter without the permission of the manufacturer.
- use a different fluid than those designed for.

## Starting Operation

Switch on the service pump.

Ventilate the filter by opening the vent plug (8.1) / vent valve (8.2), close when operating fluid appears.

## Maintenance

The filter element is clogged and must be changed or cleaned when at operating temperature the red pointer on the pop-up indicator (6) is hard against the plastic cap / the pointer on the dual dial indicator (6) is at the end of the red marking and / or the switching process on the electrical indicator is triggered.

## Filter element service

Switch off pump, open vent plug (8.1) / vent valve (8.2) and ventilate the system. Drain the filter housing through the drain plug (10) / drain valve. Unscrew filter bowl (2) and remove filter element (3), turning slightly off from its locator in the filter head (1). Check filter bowl inside and clean if necessary.

Filter element of type H...-XL,, H...-XP, AS..., P... and VS ... is to be replaced.

Filter element with G... media is cleanable. The effectiveness of cleaning depends on the type of dirt and the level of the differential pressure at the time of changing the filter element. If the differential pressure after the filter element's cleaning process exceeds more than 50% of the pre-service value the G...filter element also needs to be replaced.

Remove the safety packing from the new filter element before installing in the filter.

Replace filter element by slightly turning it back on its locator. Check Housing O-Ring (4) on filter bowl (2), replace in case of damage or wear. Screw filter bowl and tighten to the specified torque (page 4) at hexagon bolt using a suitable tool.

Operate filter as described above.

## Pressure Directives

Pressure Line Filters for hydraulic application are pressure holding equipment according to Article 2 Section 5 of the Pressure Equipment Directive 2014/68/EU. However, on the basis of the exception in Article 1, Section 2(f) of the PED the pressure line filters are exempt from the PED if they are not classified higher than category I (Guideline A-19) & do not receive any CE mark.

## Disposal / Environmental Protection

Careless disposal of the filter, filter element and the residual fluid contained therein can cause environmental pollution.

Dispose the filter / filter element in accordance with provisions applicable in the country of use.

Fluid residues are to be disposed according to the respective safety data sheets valid for the specific hydraulic fluids.

# Performance Curves (Flow rate Vs Pressure Drop) - for complete filters

Oil Viscosity : 30 mm<sup>2</sup>/s  
 Specific gravity < 0.9 kg/dm<sup>3</sup>  
 Recommended initial Pressure Drop ( $\Delta P$ ) for assembly = 0.8 bar.

... LE-0005 / LEN-0040

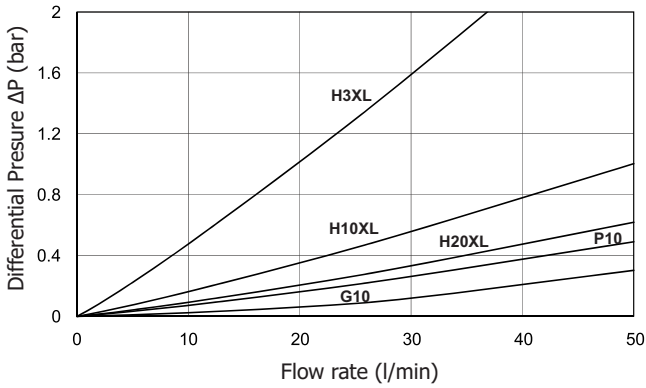

... LE-0018

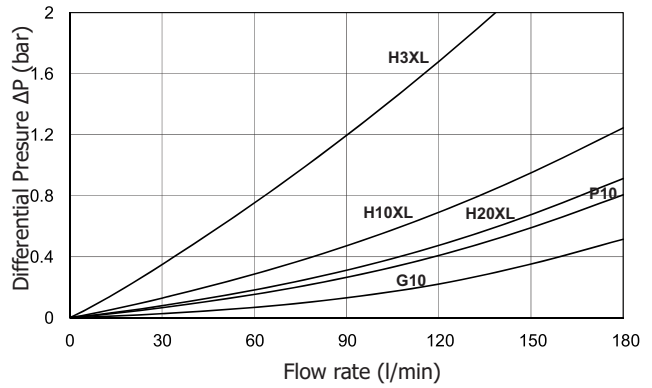

... LE-0008 / LEN-0063

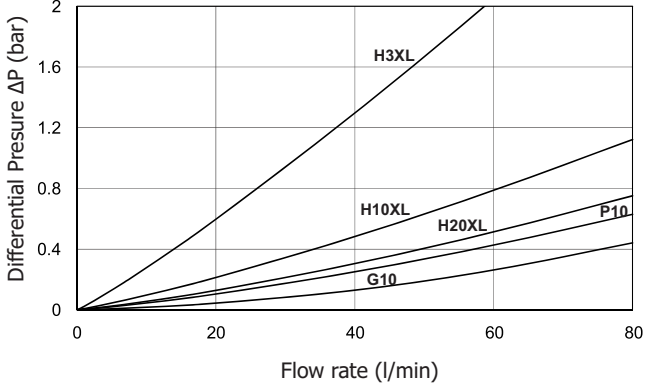

... LE-0020 / LEN-0160

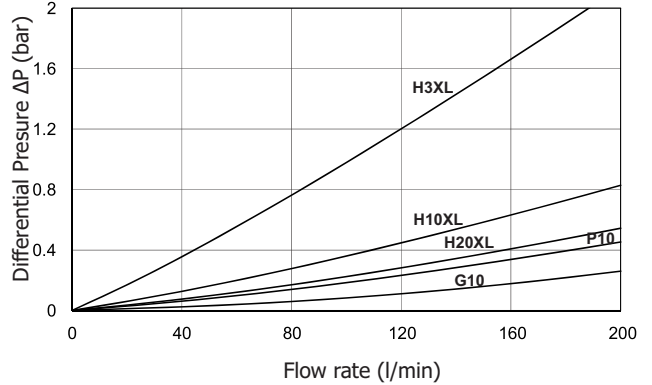

... LE-0013 / LEN-0100

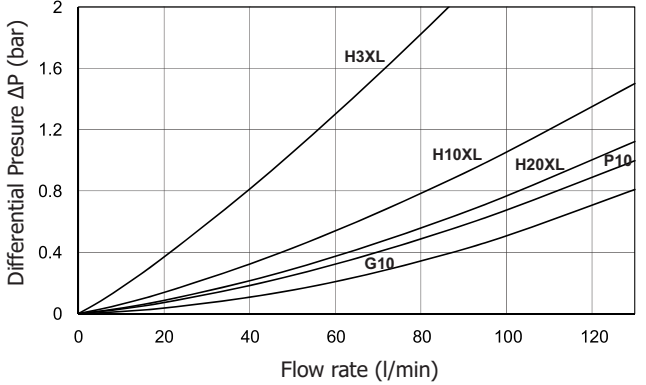

... LE-0030 / LEN-0250

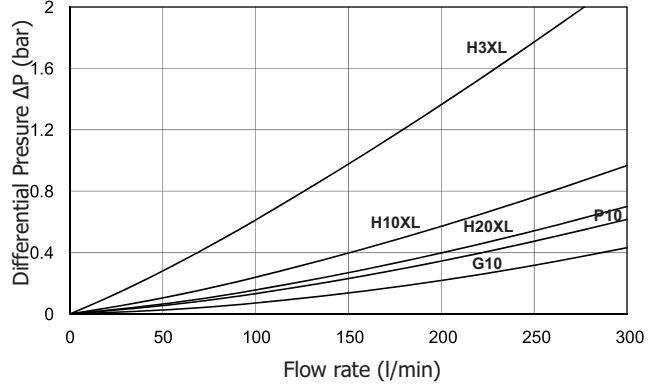

... LE-0015

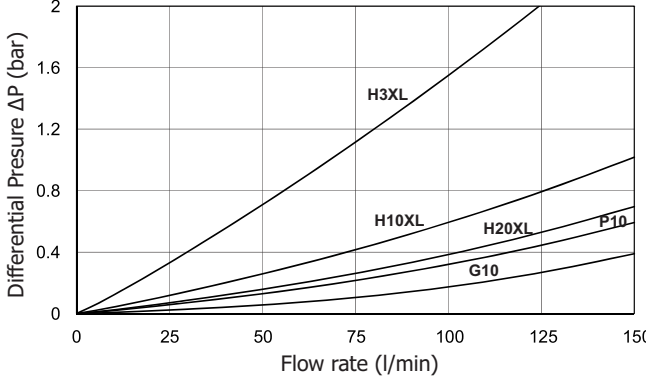

... LE-0045 / LEN-0400

